



**TREND**<sup>®</sup>  
WINDOWS

& DOORS

# TIMBER SIZE RANGE MANUAL.

**BOTANICA** Timber Series



**WE'VE SIMPLIFIED  
OUR TIMBER RANGE.**

More and more people are choosing timber windows and doors and it's simple to see why. First of all, nothing can match the natural beauty and authentic feel of timber. It's also a brilliant insulator, which helps make homes more comfortable and energy efficient. And now it's even easier for architects,

designers and builders, to specify because we have a unified size range available in Cedar and Meranti. So regardless of which species a client chooses (and even if they change their minds), you'll have standard sizes to work to.

# BOTANICA AWNING WINDOWS

– Timber available: Western Red Cedar and Meranti

– Code Prefix: To order add 'W' for Cedar and 'M' for Meranti to the front of the codes below

– This page details our standard size range, refer to page 42-43 for products maximum size

▲ Available as full width sash

● Available in full height



HEIGHT (MM)	Brick size	2.5	3	3.5	5	6	1530	6.5	
	Stud opening Frame	630 610	750 730	870 850	930 910	1230 1210	1470 1450	1590 1570	
7 620 600									
10 877 857									
920 900									
12 1050 1030									
14 1220 1200									
16 1390 1370									
17 1477 1457									
1520 1500									
21 1820 1800	600								
2120 2100	730								

7.5	2130	9	10	11
1830 1810	2110	2190 2170	2430 2410	2670 2650

# BOTANICA CASEMENT WINDOWS

– Timber available: Western Red Cedar and Meranti

– Code Prefix: To order add 'W' for Cedar and 'M' for Meranti to the front of the codes below

– This page details our standard size range, refer to page 42-43 for products maximum size

▲ Available in full height sash



		WIDTH (MM)							
		2.5	3	3.5	5	6	6.5	6.5	
Brick size		630	750	870	930	1230	1470	1530	1590
Stud opening		610	730	850	910	1210	1450	1510	1570
Frame									
HEIGHT (MM)	10								
		C0806	C0807	C0808	C0809	C0812	C0814	C0815	C0816
	877								
	920	C0906	C0907	C0908	C0909	C0912	C0914	C0915	C0916
	900								
	12	C1006	C1007	C1008	C1009	C1012	C1014	C1015	C1016
	1050								
	14	C1206	C1207	C1208	C1209	C1212	C1214	C1215	C1216
	1200								
	16	C1306	C1307	C1308	C1309	C1312	C1314	C1315	C1316
1390									
17	C1406	C1407	C1408	C1409	C1412	C1414	C1415	C1416	
1477									
1520	C1506	C1507	C1508	C1509	C1512	C1514	C1515	C1516	
1500									
21	C1806T ▲	C1807T	C1808T	C1809T	C1812T ▲	C1814T	C1815T	C1816T	
1370									
2120	C2106T ▲	C2107T	C2108T	C2109T	C2112T ▲	C2114T	C2115T	C2116T	
1800									
2100	C2106T ▲	C2107T	C2108T	C2109T	C2112T ▲	C2114T	C2115T	C2116T	

7.5	2130	9	10	11
1830	2110	2190	2430	2670
1810	2110	2170	2410	2650
C0818	C0821	C0822	C0824	C0827
C0918	C0921	C0922	C0924	C0927
C1018	C1021	C1022	C1024	C1027
C1218	C1221	C1222	C1224	C1227
C1318	C1321	C1322	C1324	C1327
C1418	C1421	C1422	C1424	C1427
C1518	C1521	C1522	C1524	C1527
C1818T	C1821T ▲	C1822T	C1824T	C1827T
C2118T	C2121T ▲	C2122T	C2124T	C2127T

# BOTANICA BI-FOLD WINDOWS

## 2 panel

2 LEFT		2 RIGHT	
WITH SCREENS	WITHOUT SCREENS	WITH SCREENS	WITHOUT SCREENS
BWS-2/2L	BW-2/2L	BWS-2/2R	BW-2/2R

## 3 panel

2 LEFT		2 RIGHT	
WITH SCREENS	WITHOUT SCREENS	WITH SCREENS	WITHOUT SCREENS
BWS-3/3L	BW-3/3L	BWS-3/3R	BW-3/3R

## 4 panel

4 LEFT		2 LEFT / 2 RIGHT		4 RIGHT	
WITH SCREENS	WITHOUT SCREENS	WITH SCREENS	WITHOUT SCREENS	WITH SCREENS	WITHOUT SCREENS
BWS-4/4L	BW-4/4L	BWS-4/2L2R	BW-4/2L2R	BWS-4/4R	BW-4/4R

- Timber available: Western Red Cedar and Meranti
- Code Prefix: To order add 'W' for Cedar and 'M' for Meranti to the front of the codes below
- This page details our standard configurations, refer to page 42-43 for products maximum size
- All bi-fold windows open outwards
- Bi-fold windows are top hung. The weight of the bi-fold window must be considered in the structural beam calculation of the overall structure
- The bi-fold window and frame are not structural elements and the head of the frame should be attached to the structural beam



# BOTANICA SLIDING WINDOWS

- Timber available: Western Red Cedar and Meranti

- Code Prefix: To order add 'W' for Cedar and 'M' for Meranti to the front of the codes below

- This page details our standard size range, refer to page 42-43 for products maximum size

- All sliding windows feature an internal sliding sash



		WIDTH (MM)					
		Brick size					
		Stud opening	930	1230	1470	1530	1590
		Frame	910	1210	1450	1510	1570
HEIGHT (MM)	7						
	620 600	S0608	S0609	S0612	S0614	S0615	S0616
10							
	877 857	S0808	S0809	S0812	S0814	S0815	S0816
920							
	900	S0908	S0909	S0912	S0914	S0915	S0916
12							
	1050 1030	S1008	S1009	S1012	S1014	S1015	S1016
14							
	1220 1200	S1208	S1209	S1212	S1214	S1215	S1216
16							
	1390 1370	S1308	S1309	S1312	S1314	S1315	S1316
17							
	1477 1457	S1408	S1409	S1412	S1414	S1415	S1416
1520							
	1500	S1508	S1509	S1512	S1514	S1515	S1516
1370							
	665 21 1820 1800	S1808T	S1809T	S1812T	S1814T	S1815T	S1816T
1200							
	900 2120 2100	S2108T	S2109T	S2112T	S2114T	S2115T	S2116T

		7.5		9	10	11
		1830	2130	2190	2430	2670
		1810	2110	2170	2410	2650
HEIGHT (MM)	7					
	620 600	S0618	S0621	S0622	S0624	S0627
10						
	877 857	S0818	S0821	S0822	S0824	S0827
920						
	900	S0918	S0921	S0922	S0924	S0927
12						
	1050 1030	S1018	S1021	S1022	S1024	S1027
14						
	1220 1200	S1218	S1221	S1222	S1224	S1227
16						
	1390 1370	S1318	S1321	S1322	S1324	S1327
17						
	1477 1457	S1418	S1421	S1422	S1424	S1427
1520						
	1500	S1518	S1521	S1522	S1524	S1527
1370						
	665 21 1820 1800	S1818T	S1821T	S1822T	S1824T	S1827T
1200						
	900 2120 2100	S2118T	S2121T	S2122T	S2124T	S2127T

# BOTANICA TRADITIONAL DOUBLE HUNG

- Timber available: Western Red Cedar and Meranti
- Code Prefix: To order add 'W' for Cedar and 'M' for Meranti to the front of the codes below
- This page details our standard size range, refer to page 42-43 for products maximum size
- Decorative horns available as an option, 63mm stile required
- ▲ Available in full height



		WIDTH (MM)							
		2.5	3	3.5	5	6	1530	6.5	
		Brick size Stud opening Frame	630 730	870 850	930 910	1230 1210	1470 1450	1530 1510	6.5 1590 1570
HEIGHT (MM)	10 877 857								
	D0806	D0807	D0808	D0809	D0812	D0814	D0815	D0816	
	920 900								
	D0906	D0907	D0908	D0909	D0912	D0914	D0915	D0916	
	12 1050 1030								
	D1006	D1007	D1008	D1009	D1012	D1014	D1015	D1016	
	14 1220 1200								
	D1206	D1207	D1208	D1209	D1212	D1214	D1215	D1216	
16 1390 1370									
D1306	D1307	D1308	D1309	D1312	D1314	D1315	D1316		
17 1477 1457									
D1406	D1407	D1408	D1409	D1412	D1414	D1415	D1416		
1520 1500									
D1506	D1507	D1508	D1509	D1512	D1514	D1515	D1516		
21 1820 1800									
D1806	D1807	D1808	D1809	D1812	D1814	D1815	D1816		
2120 2100									
D2106T ▲	D2107T ▲	D2108T ▲	D2109T ▲	D2112T ▲	D2114T ▲	D2115T ▲	D2116T ▲		

7.5	2130	9	10	11
1830 1810	2130 2110	2190 2170	2430 2410	2670 2650
D0818	D0821	D0822	D0824	D0827
D0918	D0921	D0922	D0924	D0927
D1018	D1021	D1022	D1024	D1027
D1218	D1221	D1222	D1224	D1227
D1318	D1321	D1322	D1324	D1327
D1418	D1421	D1422	D1424	D1427
D1518	D1521	D1522	D1524	D1527
D1818	D1821	D1822	D1824	D1827
D2118T ▲	D2121T ▲	D2122T ▲	D2124T ▲	D2127T ▲

# BOTANICA COUNTERBALANCE DOUBLE HUNG

- Timber available: Western Red Cedar and Meranti
- Code Prefix: To order add 'W' for Cedar and 'M' for Meranti to the front of the codes below
- This page details our standard size range, refer to page 42-43 for products maximum size
- Decorative horns available as an option, 63mm stile required
- ▲ Available in full height sash



		WIDTH (MM)							
		2.5	3	3.5	5	6	1530	6.5	
		Brick size Stud opening Frame	630 730	870 850	930 910	1230 1210	1470 1450	1530 1510	6.5 1590 1570
HEIGHT (MM)	10 877 857								
	B0806	B0807	B0808	B0809	B0812	B0814	B0815	B0816	
	920 900								
	B0906	B0907	B0908	B0909	B0912	B0914	B0915	B0916	
	12 1050 1030								
	B1006	B1007	B1008	B1009	B1012	B1014	B1015	B1016	
	14 1220 1200								
	B1206	B1207	B1208	B1209	B1212	B1214	B1215	B1216	
16 1390 1370									
B1306	B1307	B1308	B1309	B1312	B1314	B1315	B1316		
17 1477 1457									
B1406	B1407	B1408	B1409	B1412	B1414	B1415	B1416		
1520 1500									
B1506	B1507	B1508	B1509	B1512	B1514	B1515	B1516		
21 1820 1800									
B1806	B1807	B1808	B1809	B1812	B1814	B1815	B1816		
2120 2100									
B2106T ▲	B2107T ▲	B2108T ▲	B2109T ▲	B2112T ▲	B2114T ▲	B2115T ▲	B2116T ▲		

7.5	2130	9	10	11
1830 1810	2130 2110	2190 2170	2430 2410	2670 2650
B0818	B0821	B0822	B0824	B0827
B0918	B0921	B0922	B0924	B0927
B1018	B1021	B1022	B1024	B1027
B1218	B1221	B1222	B1224	B1227
B1318	B1321	B1322	B1324	B1327
B1418	B1421	B1422	B1424	B1427
B1518	B1521	B1522	B1524	B1527
B1818	B1821	B1822	B1824	B1827
B2118T ▲	B2121T ▲	B2122T ▲	B2124T ▲	B2127T ▲



# ANEETA SASHLESS WINDOWS

- Timber available: Western Red Cedar and Meranti

- Code Prefix: To order add 'W' for Cedar and 'M' for Meranti to the front of the codes below

▲ Available with a transom

- Colour of Aneeta aluminium insert must be specified at time of order



		WIDTH (MM)							
		2.5	3	3.5	930	5	6	1530	6.5
Brick size		630	750	870	930	1230	1470	1530	1590
Stud opening		610	730	850	910	1210	1450	1510	1570
Frame		610	730	850	910	1210	1450	1510	1570
HEIGHT (MM)	10 877 857								
	920 900								
	12 1050 1030								
	14 1220 1200								
	16 1390 1370								
	17 1477 1457								
	1520 1500								
	21 1820 1800								
	2120 2100								

7.5		9	10	11
1870	2170	2230	2470	2710
1810	2110	2170	2410	2650

# BOTANICA BREEZWAY LOUVRE WINDOWS

- Timber available: Western Red Cedar and Meranti
- Code Prefix: To order add 'W' for Cedar and 'M' for Meranti to the front of the codes below
- The below sizes are for a 152mm blade. 102mm blade also available
- Colour of Breezway aluminium insert must be specified at time of order



		WIDTH (MM)								
		430	2.5 630	930	1217	1817	1804	2704	3591	4478
		Stud opening 410	610	910	1197	1797	1784	2684	3571	4458
HEIGHT (MM)	Brick size									
	413 393	L0404/1	L0406/1	L0409/1	L0412/2	L0418/2	L0418/3	L0427/3	L0436/4	L0445/5
553 533	L0504/1	L0506/1	L0509/1	L0512/2	L0518/2	L0518/3	L0527/3	L0536/4	L0545/5	
693 673	L0704/1	L0706/1	L0709/1	L0712/2	L0718/2	L0718/3	L0727/3	L0736/4	L0745/5	
883 813	L0804/1	L0806/1	L0809/1	L0812/2	L0818/2	L0818/3	L0827/3	L0836/4	L0845/5	
11 973 953	L0904/1	L0906/1	L0909/1	L0912/2	L0918/2	L0918/3	L0927/3	L0936/4	L0945/5	
1113 1093	L1104/1	L1106/1	L1109/1	L1112/2	L1118/2	L1118/3	L1127/3	L1136/4	L1145/5	
1253 1233	L1204/1	L1206/1	L1209/1	L1212/2	L1218/2	L1218/3	L1227/3	L1236/4	L1245/5	
16 1393 1373	L1404/1	L1406/1	L1409/1	L1412/2	L0418/2	L1418/3	L1427/3	L1436/4	L1445/5	
1533 1513	L1504/1	L1506/1	L1509/1	L1512/2	L1518/2	L1518/3	L1527/3	L1536/4	L1545/5	
1673 1653	L1604/1	L1606/1	L1609/1	L1612/2	L1618/2	L1618/3	L1627/3	L1636/4	L1645/5	
21 1813 1793	L1804/1	L1806/1	L1809/1	L1812/2	L1818/2	L1818/3	L1827/3	L1836/4	L1845/5	
1953 1933	L1904/1	L1906/1	L1909/1	L1912/2	L1918/2	L1918/3	L1927/3	L1936/4	L1945/5	

		WIDTH (MM)								
		430	2.5 630	930	1217	1817	1804	2704	3591	4478
		Stud opening 410	610	910	1197	1797	1784	2684	3571	4458
HEIGHT (MM)	Brick size									
	2093 2073	L2104/1	L2106/1	L2109/1	L2112/2	L2118/2	L2118/3	L2127/3	L2136/4	L2145/5
2233 2213	L2204/1	L2206/1	L2209/1	L2212/2	L2218/2	L2218/3	L2227/3	L2236/4	L2245/5	
2373 2353	L2304/1	L2306/1	L2309/1	L2312/2	L2318/2	L2318/3	L2327/3	L2336/4	L2345/5	
29 2513 2493	L2504/1	L2506/1	L2509/1	L2512/2	L2518/2	L2518/3	L2527/3	L2536/4	L2545/5	
2653 2633	L2604/1	L2606/1	L2609/1	L2612/2	L2618/2	L2618/3	L2627/3	L2636/4	L2645/5	
2793 2773	L2804/1	L2806/1	L2809/1	L2812/2	L2818/2	L2818/3	L2827/3	L2836/4	L2845/5	
21 2933 2913	L2904/1	L2906/1	L2909/1	L2912/2	L2918/2	L2918/3	L2927/3	L2936/4	L2945/5	
3073 3053	L3004/1	L3006/1	L3009/1	L3012/2	L3018/2	L3018/3	L3027/3	L3036/4	L3045/5	

# BOTANICA FIXED WINDOWS

## Bay windows

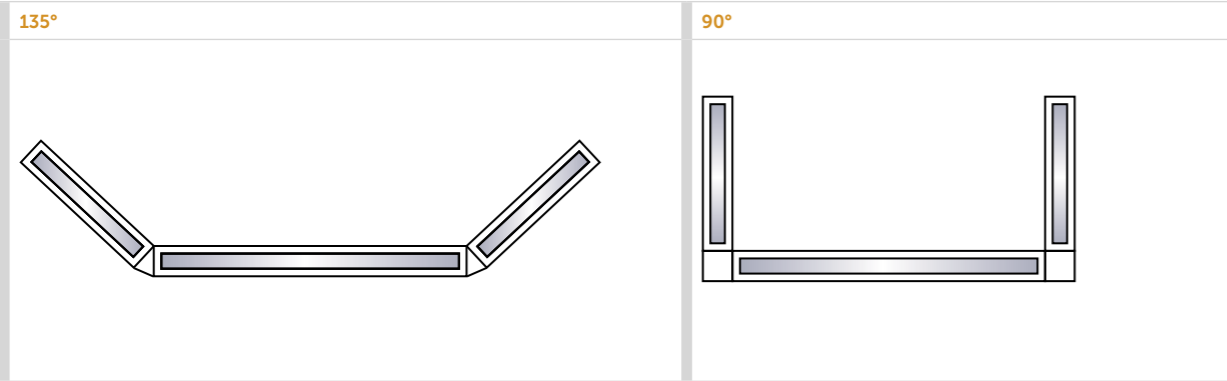

## Silicone butt joints

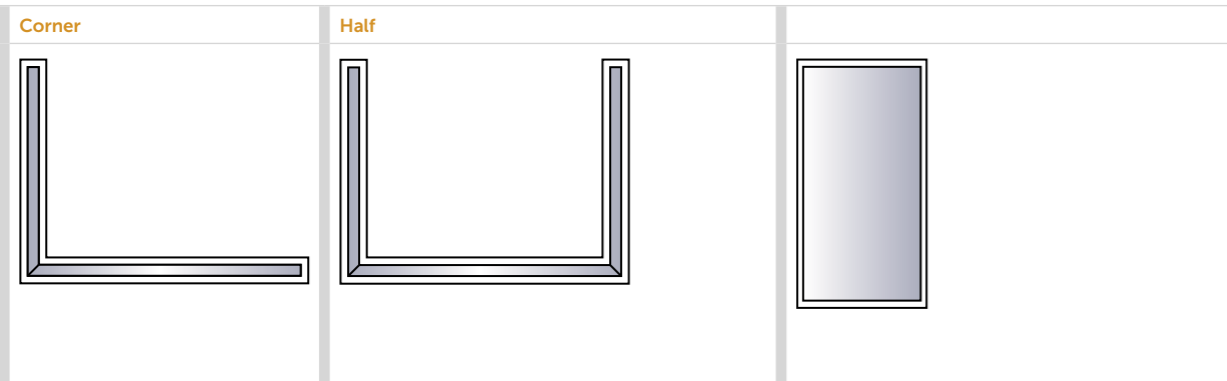

## Rakes

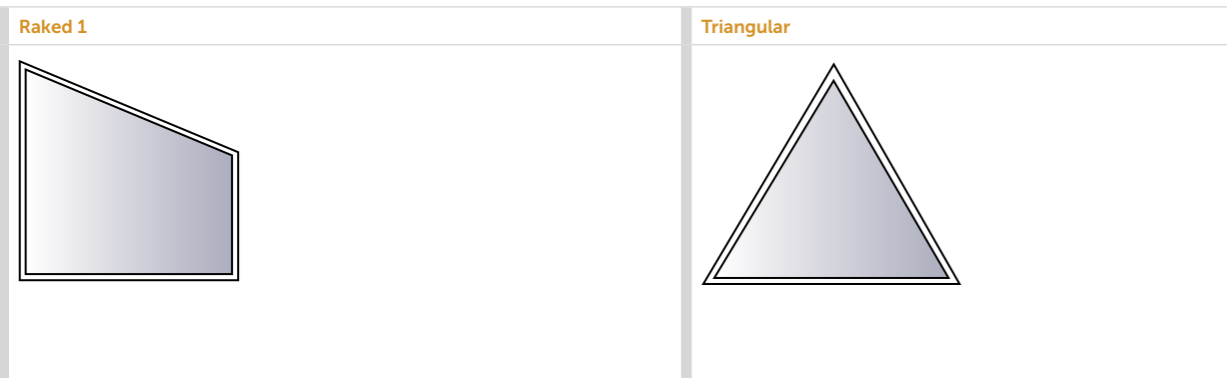

# BOTANICA CUSTOMISED OPTIONS

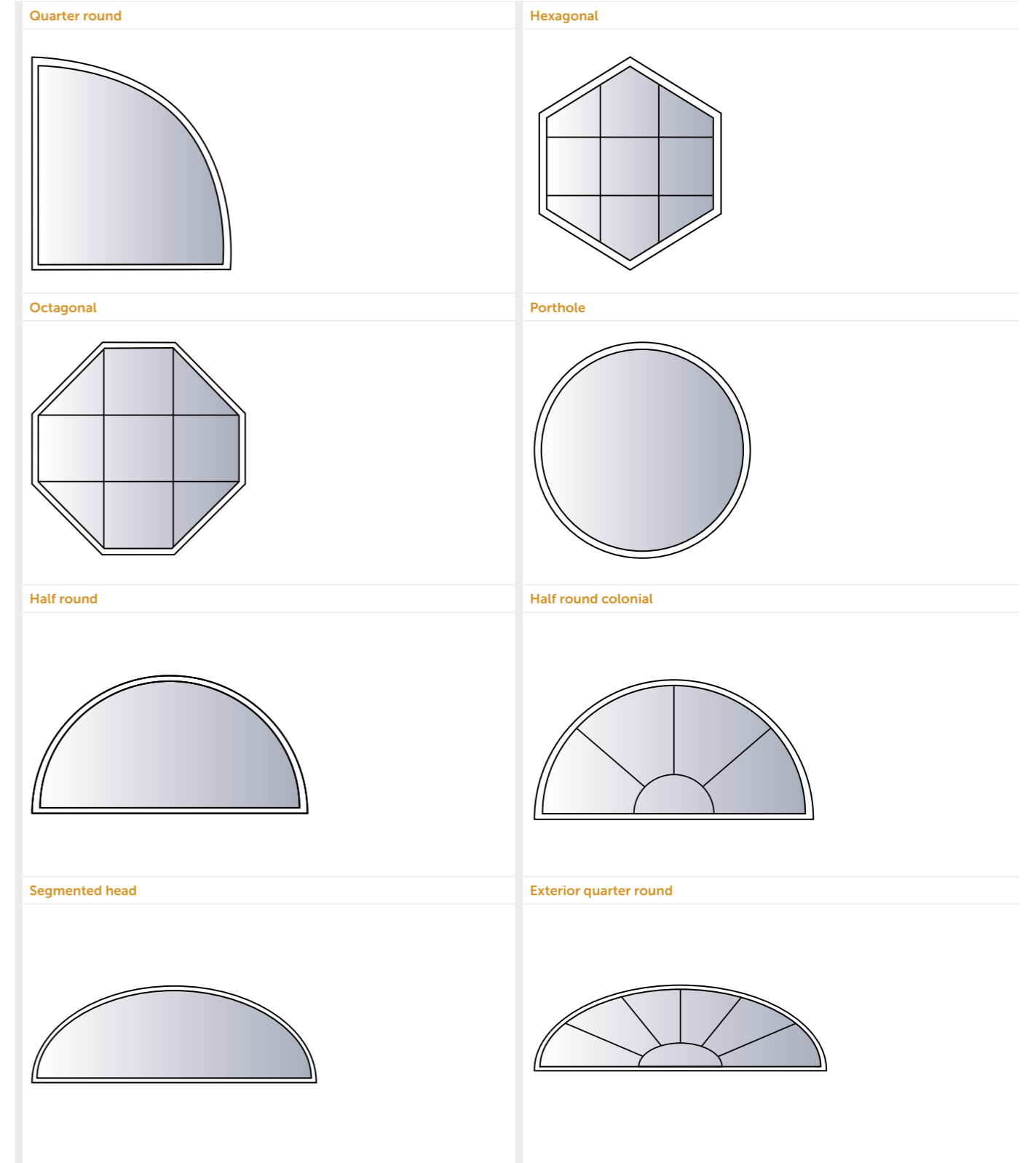

# BOTANICA SLIDING DOORS

- Timber available: Western Red Cedar and Meranti
- Code Prefix: To order add 'W' for Cedar and 'M' for Meranti to the front of the codes below
- This page details our standard size range, refer to page 42-43 for products maximum size



## 2 lite sliding door

		WIDTH (MM)			
		Brick size Stud opening Frame	7.5 1830 1810	2130 2110	10 2430 2410
HEIGHT (MM)	2120		XD2118	XD2121	XD2124
	2100				

## 3 lite sliding door

		WIDTH (MM)			
		Brick size Stud opening Frame	11.5 2792 2772	13.5 3242 3222	3692 3672
HEIGHT (MM)	2120		XD2128	XD2132	XD2137
	2100				

## 4 lite sliding door

		WIDTH (MM)					
		Brick size Stud opening Frame	2724 2704	13 3124 3104	3580 3560	4180 4160	4780 4760
HEIGHT (MM)	2120		XD2127	XD2131	XD2136	XD2142	XD2147
	2100						

# BOTANICA STACKER DOORS

- Timber available: Western Red Cedar and Meranti
- Code Prefix: To order add 'W' for Cedar and 'M' for Meranti to the front of the codes below
- This page details our standard size range, refer to page 42-43 for products maximum size



## 3 lite stacking door

		WIDTH (MM)					
		Brick size Stud opening Frame	2012 1992	2312 2292	11 2654 2634	3104 3084	3554 3534
HEIGHT (MM)	2120		SD2120	SD2123	SD2126	SD2131	SD2135
	2100						

## 6 lite stacking door

		WIDTH (MM)		
		Brick size Stud opening Frame	4544 4524	5228 5208
HEIGHT (MM)	2120		SD2145	SD2152
	2100			

# BOTANICA BI-FOLD DOORS

## 2 panel

WIDTH (MM)	2 LEFT	2 RIGHT
1310	BF2113/2L	BF2113/2R
1510	BF2115/2L	BF2115/2R
1710	BF2117/2L	BF2117/2R

## 3 panel

WIDTH (MM)	3 LEFT	2 LEFT, 1 RIGHT	1 LEFT, 2 RIGHT	3 RIGHT
1934	BF2119/3L	BF2119/2L1R	BF2119/1L2R	BF2119/3R
2234	BF2122/3L	BF2122/2L1R	BF2122/1L2R	BF2122/3R
2534	BF2125/3L	BF2125/2L1R	BF2125/1L2R	BF2125/3R

## 4 panel

WIDTH (MM)	4 LEFT	3 LEFT, 1 RIGHT	2 LEFT, 2 RIGHT	1 LEFT, 3 RIGHT
2558	BF2126/4L	BF2126/3L1R	BF2126/2L2R	BF2126/1L3R
2958	BF2130/4L	BF2130/3L1R	BF2130/2L2R	BF2130/1L3R
3358	BF2134/4L	BF2134/3L1R	BF2134/2L2R	BF2134/1L3R

## 5 panel

WIDTH (MM)	5 LEFT	4 LEFT, 1 RIGHT	3 LEFT, 2 RIGHT	2 LEFT, 3 RIGHT
3182	BF2132/5L	BF2132/4L1R	BF2132/3L2R	BF2132/2L3R
3682	BF2137/5L	BF2137/4L1R	BF2137/3L2R	BF2137/2L3R
4182	BF2142/5L	BF2142/4L1R	BF2142/3L2R	BF2142/2L3R

## 6 panel

WIDTH (MM)	6 LEFT	5 LEFT, 1 RIGHT	4 LEFT, 2 RIGHT	3 LEFT, 3 RIGHT
3806	BF2138/6L	BF2138/5L1R	BF2138/4L2R	BF2138/3L3R
4406	BF2144/6L	BF2144/5L1R	BF2144/4L2R	BF2144/3L3R
5006	BF2150/6L	BF2150/5L1R	BF2150/4L2R	BF2150/3L3R

## 7 panel

WIDTH (MM)	7 LEFT	6 LEFT, 1 RIGHT	5 LEFT, 2 RIGHT	4 LEFT, 3 RIGHT
4430	BF2144/7L	BF2144/6L1R	BF2144/5L2R	BF2144/4L3R
5130	BF2151/7L	BF2151/6L1R	BF2151/5L2R	BF2151/4L3R
5830	BF2158/7L	BF2158/6L1R	BF2158/5L2R	BF2158/4L3R

- Timber available: Western Red Cedar and Meranti
- Code Prefix: To order add 'W' for Cedar and 'M' for Meranti to the front of the codes below
- This page details our standard size range, refer to page 42-43 for products maximum size
- All bi-fold doors open outwards
- The bi-fold door is top hung. The weight of the bi-fold door must be considered in the structural beam calculation of the overall structure
- The bi-fold door and frame are not structural elements and the head of the frame should be attached to the structural beam



## Corner bi-folds

Internal corner

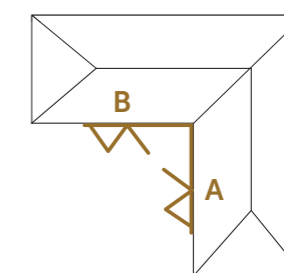

External corner

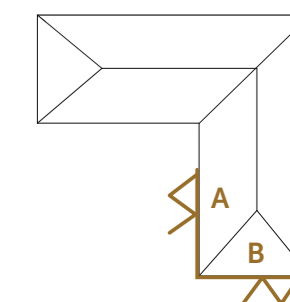

Corner bi-fold doors use generic codes which are not size specific. When ordering a corner door specify the height and both A and B width. Corner bi-folds must have an odd number of doors each way.

4 RIGHT
BF2126/4R
BF2130/4R
BF2134/4R

1 LEFT, 4 RIGHT	5 RIGHT
BF2132/1L4R	BF2132/5R
BF2137/1L4R	BF2137/5R
BF2142/1L4R	BF2142/5R

2 LEFT, 4 RIGHT	1 LEFT, 5 RIGHT	6 RIGHT
BF2138/2L4R	BF2138/1L5R	BF2138/6R
BF2144/2L4R	BF2144/1L5R	BF2144/6R
BF2150/2L4R	BF2150/1L5R	BF2150/6R

3 LEFT, 4 RIGHT	2 LEFT, 5 RIGHT	1 LEFT, 6 RIGHT	7 RIGHT
BF2144/3L4R	BF2144/2L5R	BF2144/1L6R	BF2144/7R
BF2151/3L4R	BF2151/2L5R	BF2151/1L6R	BF2151/7R
BF2158/3L4R	BF2158/2L5R	BF2158/1L6R	BF2158/7R

# BOTANICA ENTRY FRAMES

- Timber available: Western Red Cedar and Meranti
- Code Prefix: To order add 'W' for cedar and 'M' for Meranti to the front of the codes below
- All hinge doors open in, unless otherwise specified
- Entry frames and doors are sold separately
- Entry frame does not comply to AS2047:2014
- Hardware is not provided
- Frame sizes below to suit 2040x820 doors

## Entry frame

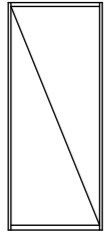
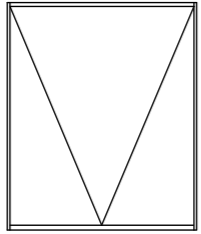
		WIDTH (MM)			
		<b>Stud opening</b>	<b>895</b>	<b>1705</b>	<b>1729</b>
		<b>Frame</b>	<b>875</b>	<b>1685*</b>	<b>1709^</b>
HEIGHT (MM)	OPEN IN	<b>2130</b>			
	IN	<b>2110</b>			
	OPEN OUT	<b>2115</b>			
	OUT	<b>2095</b>			
	NO SILL	<b>2095</b>			
	SILL	<b>2075</b>			
	OPEN IN	E2109OI	E2117OI		
	OPEN OUT	E2109OO	E2117OO		
	NO SILL	E2109DS	E2117DS		

\*To suit rebated doors  
^To suit mushroom stop doors

## Entry frame with sidelites

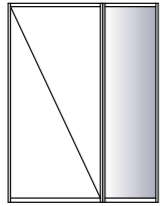
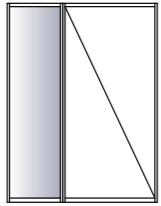
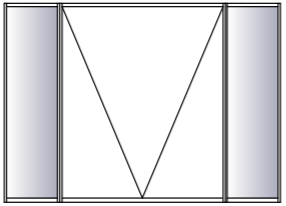
		WIDTH (MM)			
		<b>Stud opening</b>	<b>1332</b>	<b>1332</b>	<b>1763</b>
		<b>Frame</b>	<b>1312</b>	<b>1312</b>	<b>1743</b>
HEIGHT (MM)	OPEN IN	<b>2130</b>			
	IN	<b>2110</b>			
	OPEN OUT	<b>2115</b>			
	OUT	<b>2095</b>			
	NO SILL	<b>2095</b>			
	SILL	<b>2075</b>			
	OPEN IN	E2113LFOI	E2113RFOI	E2118CFOI	
	OPEN OUT	E2113LFOO	E2113RFOO	E2118CFOO	
	NO SILL	E2113LFDS	E2113RFDS	E2118CFDS	

## Laundry frame configurations

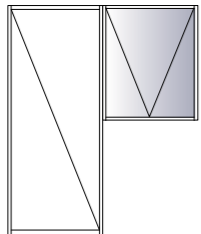
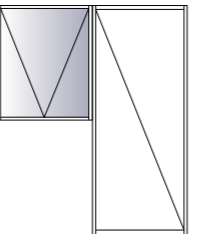





		WIDTH (MM)		
		<b>Stud opening</b>	<b>1493</b>	<b>1493</b>
		<b>Frame</b>	<b>1473</b>	<b>1473</b>
HEIGHT (MM)	OPEN IN	<b>2130</b>		
	IN	<b>2110</b>	<b>1050</b>	<b>1030</b>
	OPEN OUT	<b>2115</b>		
	OUT	<b>2095</b>		
	NO SILL	<b>2095</b>	<b>895</b>	<b>895</b>
	SILL	<b>2075</b>	<b>875</b>	<b>875</b>
	OPEN IN	L2115L/1OI	L2115R/1OI	
	OPEN OUT	L2115L/1OO	L2115R/1OO	
	NO SILL	L2115L/1DS	L2115R/1DS	

# BOTANICA DOORS & SIDELITES

## Door options

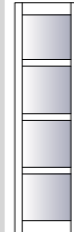
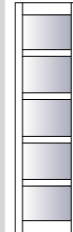
		WIDTH (MM)						
		<b>620</b>	<b>620</b>	<b>620</b>	<b>620</b>	<b>620</b>	<b>620</b>	<b>620</b>
		<b>720</b>	<b>720</b>	<b>720</b>	<b>720</b>	<b>720</b>	<b>720</b>	<b>720</b>
		<b>820</b>	<b>820</b>	<b>820</b>	<b>820</b>	<b>820</b>	<b>820</b>	<b>820</b>
HEIGHT (MM)	2040							
		WGD-5	WGD-1	WGD-3CR	WGD-CR-LM	WGD-CR-M	WGD-8	WGD-3

## Sidelite options

		WIDTH (MM)							
		<b>620</b>	<b>620</b>	<b>620</b>	<b>620</b>	<b>720</b>	<b>618</b>	<b>618</b>	<b>618</b>
		<b>720</b>	<b>720</b>	<b>720</b>	<b>720</b>	<b>820</b>			
		<b>820</b>	<b>820</b>	<b>820</b>	<b>820</b>				
HEIGHT (MM)	2040								
		FL	CR	4L/CR	5L/CR	FHL	FSP	3SP	1SP

## Rebate options

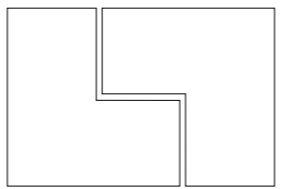
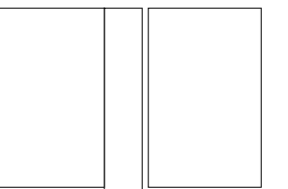
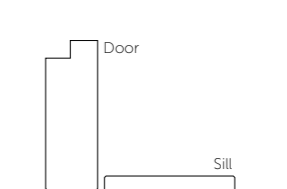
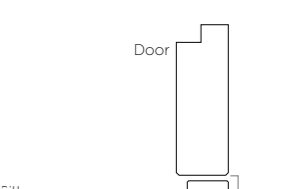
RebatedM	mushroom stop	Open out sillO	pen in sill
			

- Sill choice impacts the overall size of your door.

# BOTANICA SILL OPTIONS

## Bi-fold doors



– Builder responsible for threshold drainage and weather proofing

## Sliding and stacker doors



– Builder responsible for threshold drainage



## Bi-fold window



– Builder responsible for drainage and weather performance

# BOTANICA SCREEN OPTIONS

- Available in timber or aluminium
- Ask about our range of security screens and doors

## Bi-fold window



- Roll down screen fitted internally
- Corner bi-fold windows cannot be screened

## Sliding and stacking door



- Sliding Timber or Aluminium screen fitted externally

## Double hung



- Timber or Aluminium screen fixed externally

## Casement and awning



- Timber or Aluminium screen fixed internally

## Sliding window



- Timber or Aluminium screen fixed externally

## Sliding servery window



- Timber or Aluminium screen sliding externally

## Breezway louvre



- Timber or Aluminium screen fixed externally

## Aneeta sashless



- Timber or Aluminium screen fixed externally



# BOTANICA CEDAR HARDWARE



## WINDOW

### Double hung window



Double hung lock – Traditional



▲ Double hung lock – Contemporary



Sash lifts

### Awning and casement window



▲ Scissor winder



Scissor winder locked

### Sliding window



▲ Sliding window lock – Contemporary



Sliding window lock – Traditional

### Bi-fold window



Flush-mounted drop bolt – top

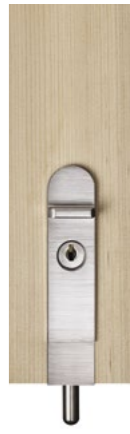

Flush-mounted drop bolt – bottom



Sash lock



Chain winder



Sash fastener

## DOOR

### Sliding and stacking doors



Archer handle (inside)



▲ Boston handle (inside)



Infinity bi-fold door handle\*



Infinity hinged door handle inside



Infinity hinged door handle outside

Note: Cedar is supplied with silver hardware as standard. The satin chrome finish may vary across hardware items. Optional black and white hardware available. Selected hardware items may not be available in white.

▲ Denotes standard hardware.



**BOTANICA  
MERANTI  
HARDWARE**

# WINDOW

## Double hung window



Double hung lock – Traditional



▲ Double hung lock – Contemporary



Sash lifts

## Awning and casement window.



Scissor winder



Scissor winder locked

## Sliding window



▲ Sliding window lock – Contemporary



Sliding window lock – Traditional

## Bi-fold window



Flush-mounted drop bolt – top



Flush-mounted drop bolt – bottom



Sash lock



▲ Chain winder



Sash fastener

# DOOR

## Sliding and stacking doors



▲ Archer handle (inside)



Boston handle (inside)

## Bi-fold door



Infinity bi-fold door handle\*



Infinity hinged door handle inside



Infinity hinged door handle outside

Note: Meranti is supplied with black hardware as standard. The black finish may vary across hardware items. Optional silver and white hardware available. Selected hardware items may not be available in white.

▲ Denotes standard hardware.

# BOTANICA DECORATIVE OPTIONS

## Ovolo bars



Incorporate Ovolo bars to achieve an authentic Colonial or Federation style. Panes of glass are painstakingly put in one-by-one, between the Ovolo bars. This effect is subtle detail, but matters to those with an eye for design. The attention to detail is noticeable.

## Powered chain winder



For a clean aesthetic, incorporate the electric winder within your awning window.

## Trend horn



## Lambs tongue horn



## Bullnose horn



## Splayed horn



# GLAZING OPTIONS

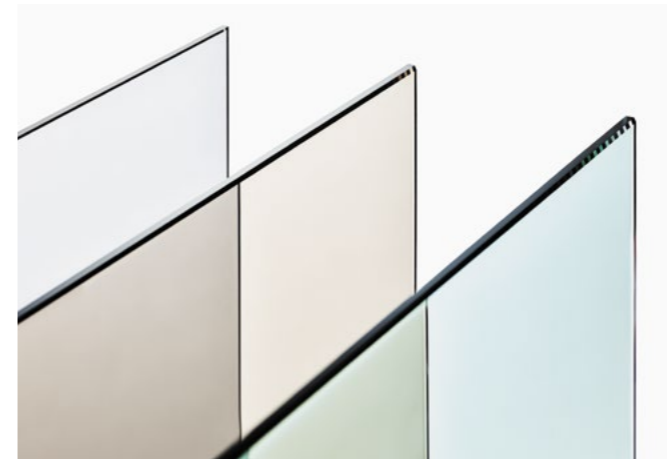

## COMFORT

### Double glazing

Double glazing is the most effective way to improve the energy efficiency of windows and doors, making your living space more comfortable all year round.

### Low E glass

Low E glass has a transparent Low Emissivity coating that reflects heat while still allowing in maximum light, helping keep your home cooler in summer and warmer in winter.

### Toned glass

Toned glass significantly reduces the sun's heat and glare, making it perfect for Australia's extreme summers.



## SERENITY

### Double glazing

Where energy efficiency and acoustics are both required double glazing can be used to reduce noise. The wider the space between the two sheets of glass, the greater the sound improvement.

### Thick glass

Thick glass is often the best choice for reducing low frequency sounds like traffic and neighbourhood noise.

### Laminated glass

Laminated glass dampens more vibrations than single glazed glass.



## SECURITY

### Toughened glass

If broken, toughened glass fractures into small particles, significantly reducing the risk of injury.

### Laminated glass

Laminated glass remains intact and resists penetration, when subject to impact.

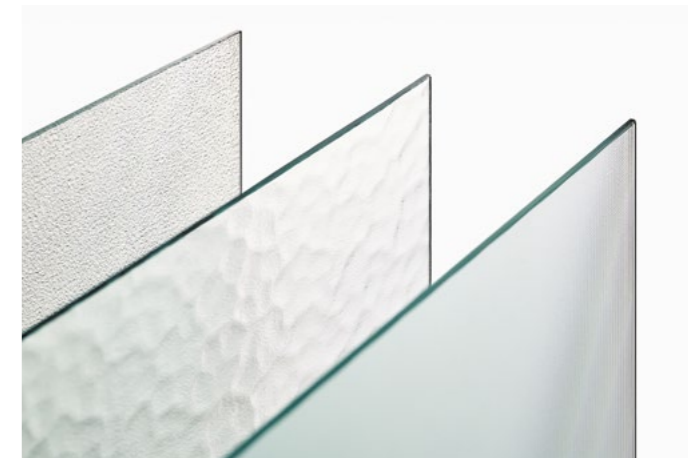

## PRIVACY

### Textured glass\*

Great for light diffusion, privacy and as a decorative feature.

### Translucent

Laminated crisp white frosted look.

### Acid etched

Acid etch has a translucent satin matte finish.

### Printed glass\*

Any pattern, texture or image can be printed directly onto the glass surface.

\*The availability of textured and printed glass options vary by state.

# BOTANICA SIZE RANGE

Product	Frame profile	Sill options	Max frame	Max sash	Sash profile	Glazing	BAL Rating	Seal type	Screen options	Hardware options
Awning	138mm x 25mm	138mm or 165mm Cedar, Meranti or Hardwood	2700mm high	2400mm high 850mm wide or 600mm high 2400mm wide Max weight 40kg	Stiles – 43mm or 63mm Top rail – 43mm or 63mm Bottom rail – 63mm	4mm – 18mm	BAL29	Compression	<ul style="list-style-type: none"> <li>Internal fixed timber or aluminium</li> <li>Security</li> </ul>	<ul style="list-style-type: none"> <li>Cedar – scissor winder</li> <li>Meranti – chain winder, or scissor winder</li> </ul>
Casement	138mm x 25mm	138mm or 165mm Cedar, Meranti or Hardwood	2700mm high	2400mm high 550mm wide or 1600mm high 850mm wide Max weight 40kg	Stiles – 63mm Top rail – 63mm Bottom rail – 63mm	4mm – 18mm	BAL29	Compression	<ul style="list-style-type: none"> <li>Internal fixed timber or aluminium</li> <li>Security</li> </ul>	<ul style="list-style-type: none"> <li>Scissor winder and Sash fastener or</li> <li>Sash lock</li> </ul>
Bi-fold window	138mm x 25mm	138mm	1600mm high	1500mm high 800mm wide	Stiles – 63mm Top rail – 63mm Bottom rail – 63mm	4mm – 18mm	N/A	Compression	N/A	<ul style="list-style-type: none"> <li>Flush mounted drop bolt</li> </ul>
Bi-fold window with screens	138mm x 25mm	138mm	1600mm high 2400mm wide	1500mm high 800mm wide	Stiles – 63mm Top rail – 63mm Bottom rail – 63mm	4mm – 18mm	N/A	Compression	<ul style="list-style-type: none"> <li>Internal – roll down (Not available for corner configuration)</li> </ul>	<ul style="list-style-type: none"> <li>Flush mounted drop bolt</li> </ul>
Sliding window	138mm x 25mm	138mm 165mm (Servery only)	2700mm high	1600mm high 1500mm wide	Stiles – 63mm Top rail – 63mm Bottom rail – 63mm	4mm – 18mm	BAL29	Mohair	<ul style="list-style-type: none"> <li>External fixed timber or aluminium</li> <li>Sliding timber or aluminium (Servery)</li> <li>Security</li> </ul>	<ul style="list-style-type: none"> <li>Sliding window lock – contemporary or</li> <li>Sliding window lock – traditional</li> </ul>
Double hung traditional	138mm x 25mm	138mm or 165mm Cedar, Meranti or Hardwood	2400mm high	1210mm high 1210mm wide Max weight 20kgs	Stiles – 43mm Top rail – 43mm or 63mm Bottom rail – 63mm	4mm – 18mm	Deemed to satisfy BAL19 (Meranti only)	Mohair	<ul style="list-style-type: none"> <li>External fixed timber or aluminium</li> <li>Security</li> </ul>	<ul style="list-style-type: none"> <li>Double hung lock – traditional or</li> <li>Double hung lock – contemporary</li> <li>Sash lifts</li> </ul>
Double hung counterbalance	138mm x 25mm	138mm or 165mm Cedar, Meranti or Hardwood	2700mm high	1350mm high 1350mm wide	Stiles – 43mm Top rail – 63mm Bottom rail – 63mm	4mm – 18mm	Deemed to satisfy BAL19 (Meranti only)	Mohair	<ul style="list-style-type: none"> <li>External fixed timber or aluminium</li> <li>Security</li> </ul>	<ul style="list-style-type: none"> <li>Double hung lock – traditional or</li> <li>Double hung lock – contemporary</li> <li>Sash lifts</li> </ul>
Fixed	138mm x 25mm	138mm or 165mm Cedar, Meranti or Hardwood	2700mm high	Single Lite 6m <sup>2</sup> per lite Multi lite 4m <sup>2</sup> per lite	N/A	4mm – 18mm	BAL29	N/A	N/A	N/A
Sliding door	165mm x 25mm	165mm	2700mm high	2700mm high 1400mm wide or 2400mm high 1800mm wide	Stiles – 110mm Top rail – 110mm Bottom rail – 138mm	4mm – 18mm	BAL29	Mohair	<ul style="list-style-type: none"> <li>External sliding timber or aluminium</li> <li>Security</li> </ul>	<ul style="list-style-type: none"> <li>Boston handle or</li> <li>Archer handle</li> </ul>
Stacker door	250mm x 25mm	250mm	2700mm high	2700mm high 1400mm wide or 2400mm high 1800mm wide	Stiles – 110mm Top rail – 110mm Bottom rail – 138mm	4mm – 18mm	BAL29	Mohair	<ul style="list-style-type: none"> <li>External sliding timber or aluminium</li> <li>Security</li> </ul>	<ul style="list-style-type: none"> <li>Boston handle or</li> <li>Archer handle</li> </ul>
Bi-fold door	165mm x 25mm	165mm	2700mm high	2700mm high 820mm wide or 2400mm high 920mm wide	Stiles – 110mm Top rail – 110mm Bottom rail – 138mm	4mm – 18mm	BAL19 (Meranti only)	Compression	N/A	<ul style="list-style-type: none"> <li>Infinity bi-fold door handle, and</li> <li>Infinity hinged door handle 4 point</li> </ul>
Entry frame	138mm x 25mm	138mm or 165mm Cedar, Meranti or Hardwood	2700mm high	N/A	N/A	4mm – 18mm	Deemed to satisfy BAL19 (Meranti only)	N/A	<ul style="list-style-type: none"> <li>External or internal timber or aluminium</li> <li>Security</li> </ul>	N/Az
Door	N/A	N/A	2700mm high	2700mm high 1200mm wide	Stiles – 110mm Top rail – 110mm Bottom rail – 138mm	4mm – 18mm	Deemed to satisfy BAL19 (Meranti only)	N/A	N/A	N/A



Call **13 72 74**

or visit **[trendwindows.com.au](http://trendwindows.com.au)**

for your nearest location

Whilst the utmost care is taken to ensure the accuracy of the information contained herein, it is provided in the understanding that the company shall under no circumstances be liable for any injuries, expenses or other losses which may in any way be attributable to the use or adoption of such data and/or design details. Trend Windows and Doors reserves the right to alter or amend without prior notice data and design details specified herein. Due to limitations with the photographic and printing process, the colours depicted in this brochure may not reflect the actual colour. Always confirm your colour choice with the paint manufacturer's colour swatches or samples. When maintaining your paint finish refer to Trend Windows and Doors care and maintenance guidelines and follow the paint manufacturer's instructions.

Re-Order Code JWTNAT0608/0923. JELD0942